

DESCRIPTIF

Menuiseries en Aluminium
Gammiste : KAWNEER
Gamme : Kasting AA3765
Avis technique : 6/13-2161

COLORIS

Aluminium thermolaqué
Label QUALICOAT
Monocouleur ou Bicolore

VITRAGE

Vitrage 28 mm 4/20/4
isolation thermique
renforcée (ITR)
remplissage gaz Argon
intercalaire Warm-edge

PERFORMANCES

Etanchéité à l'air : A3
Etanchéité à l'eau : E7B
Résistance au vent : VA2

UW : 1.7

DORMANTS

Isolation de 140

Isolation de 160

Isolation de 180

Isolation de 200

Monorail

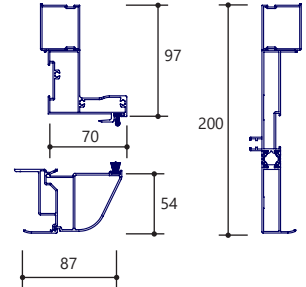
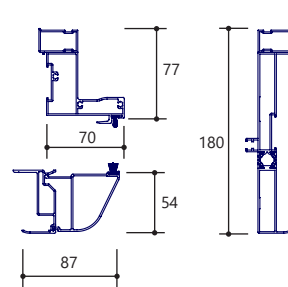
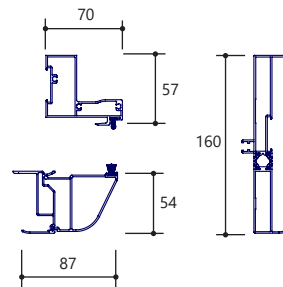
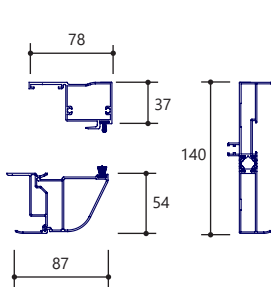

Birail

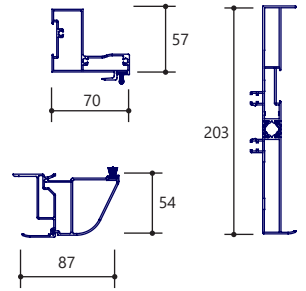
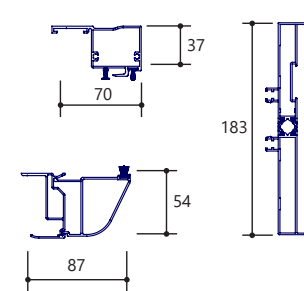

OUVRANTS

Baies coulissantes
1 vantail - monorail
dormant de 140 à 200 mm

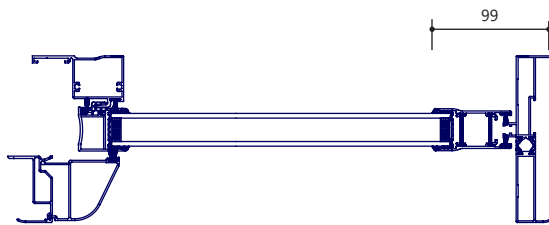

Baies coulissantes
2 vantaux - monorail
dormant de 140 à 200 mm

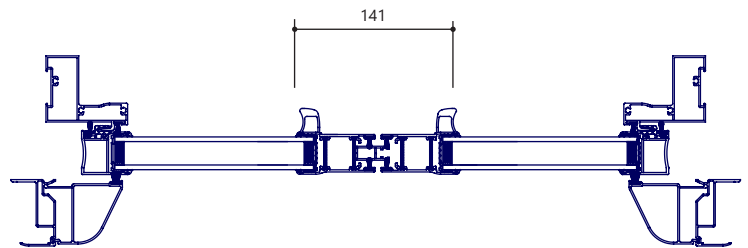

Baies coulissantes
2 vantaux - birail
dormant de 180 à 200 mm

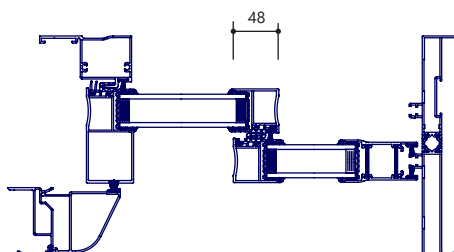

Baies coulissantes
4 vantaux - birail
dormant de 180 à 200 mm

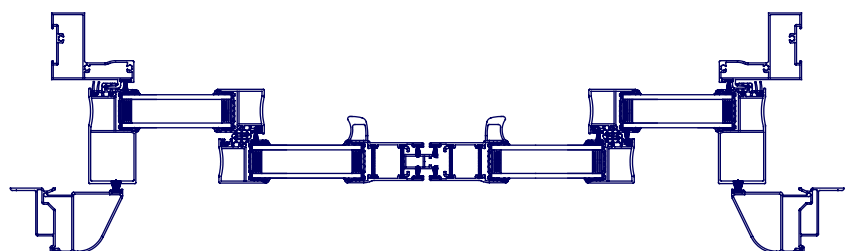

Fig 1. Coupe horizontale

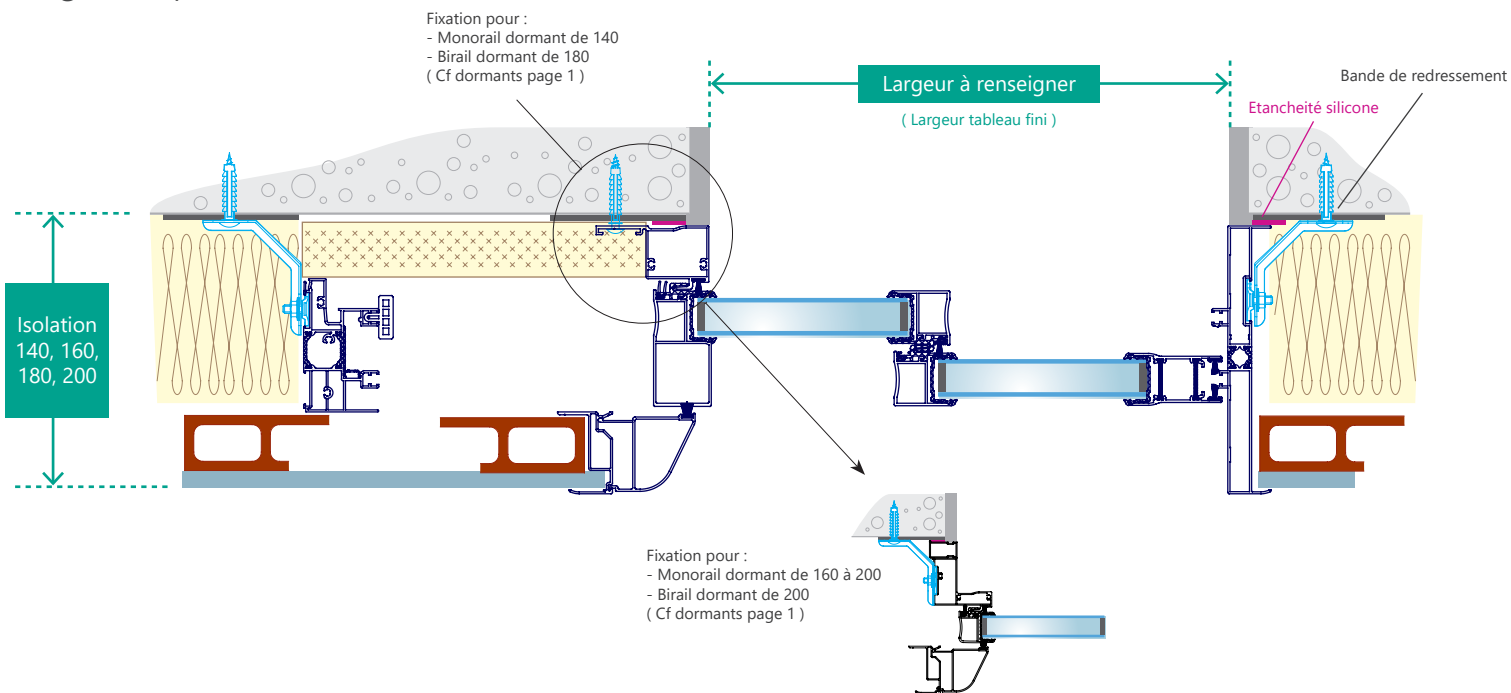

Fig 2. Coupe verticale

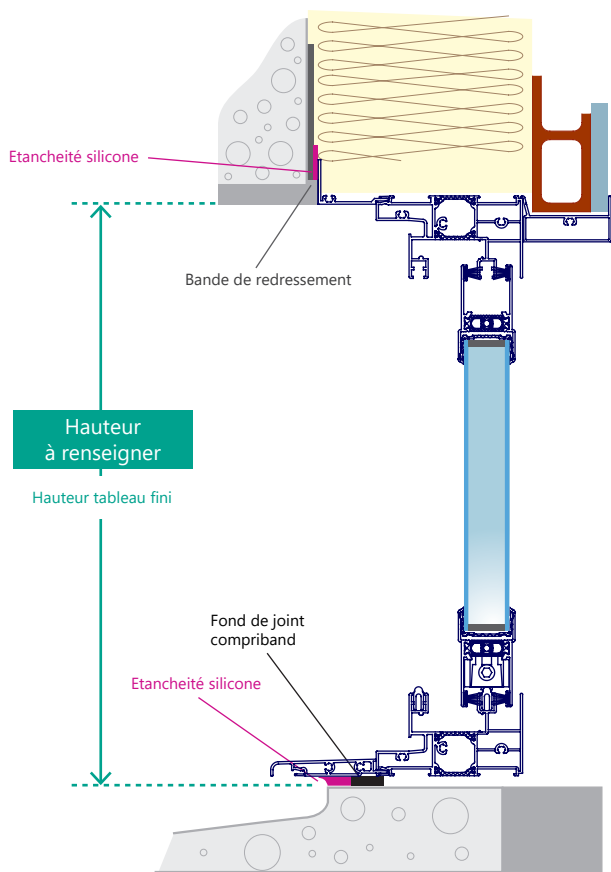

Fig 3. Seuil encastré

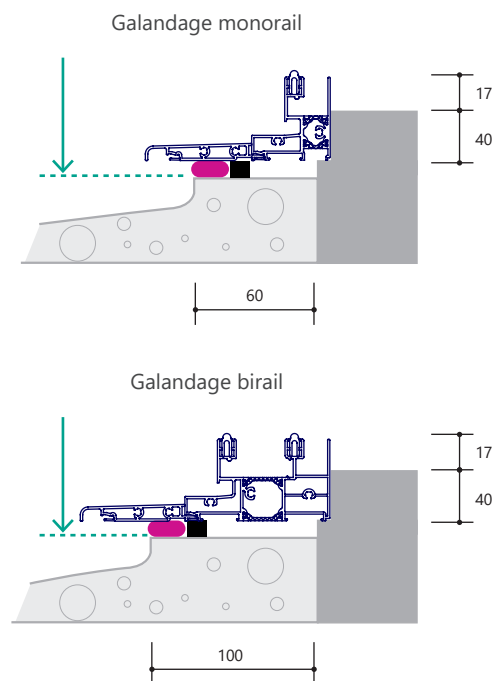

Fig 4. Coupe horizontale

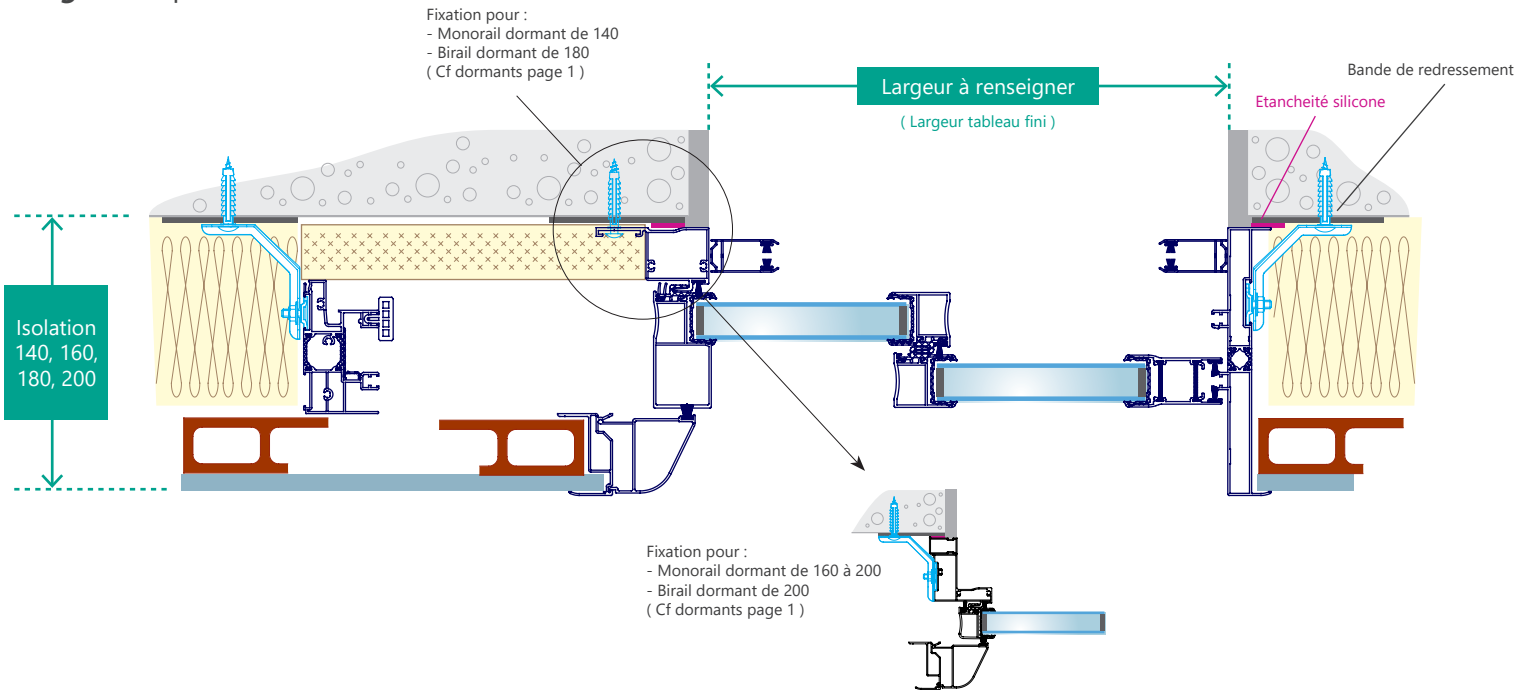

Fig 5. Coupe verticale

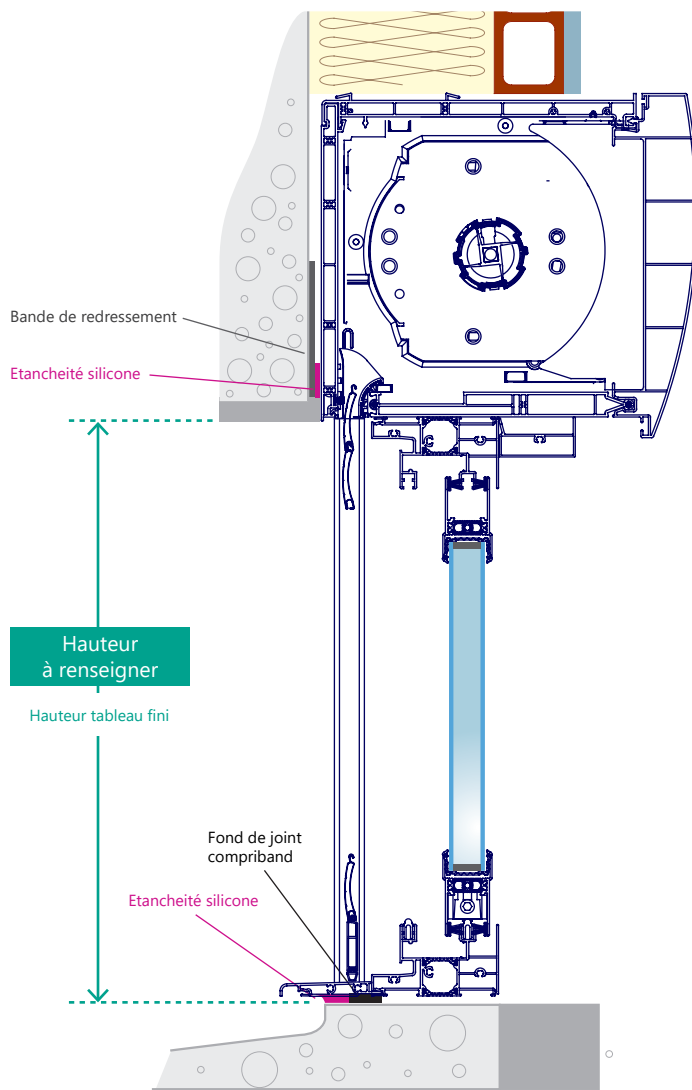

Fig 3. Seuil encastré

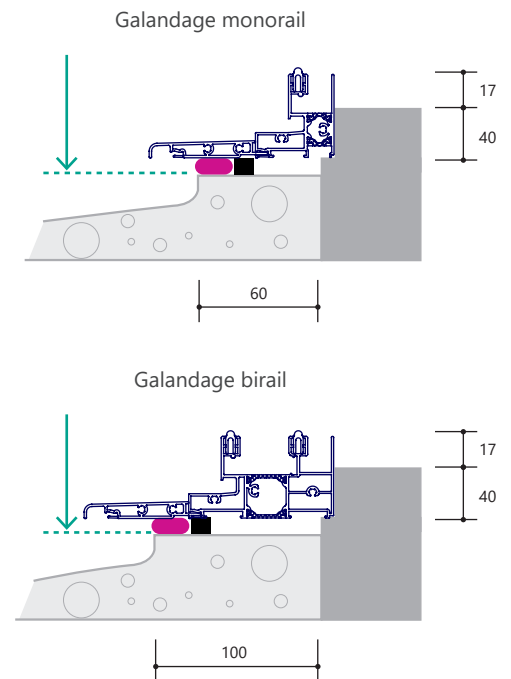

Fig6. Coupe horizontale

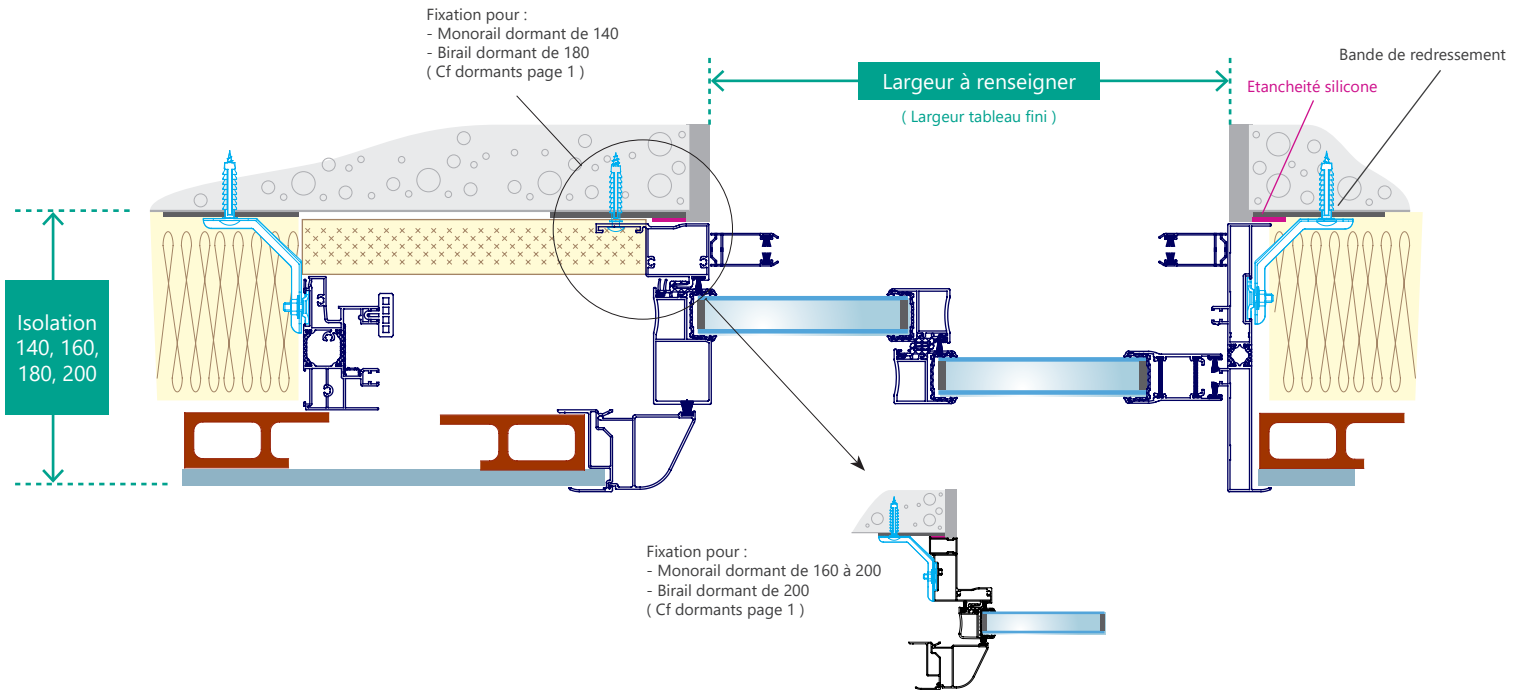

Fig 7. Coupe verticale

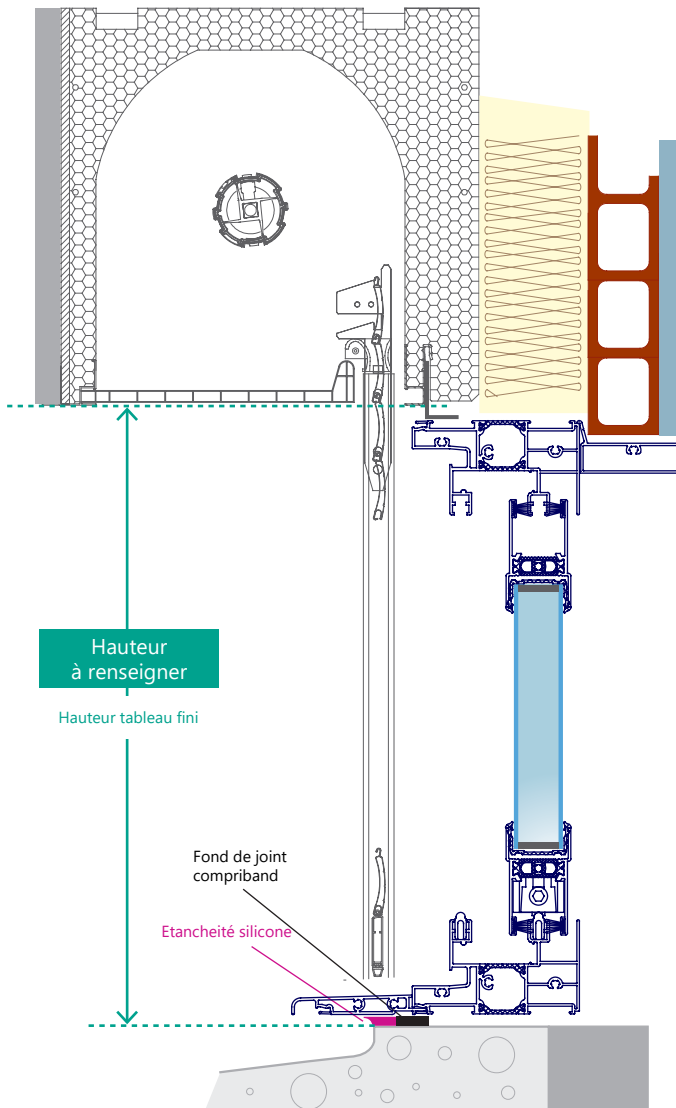

Fig 3. Seuil encastré

